

# H390

Setup Guide  
Guide d'installation

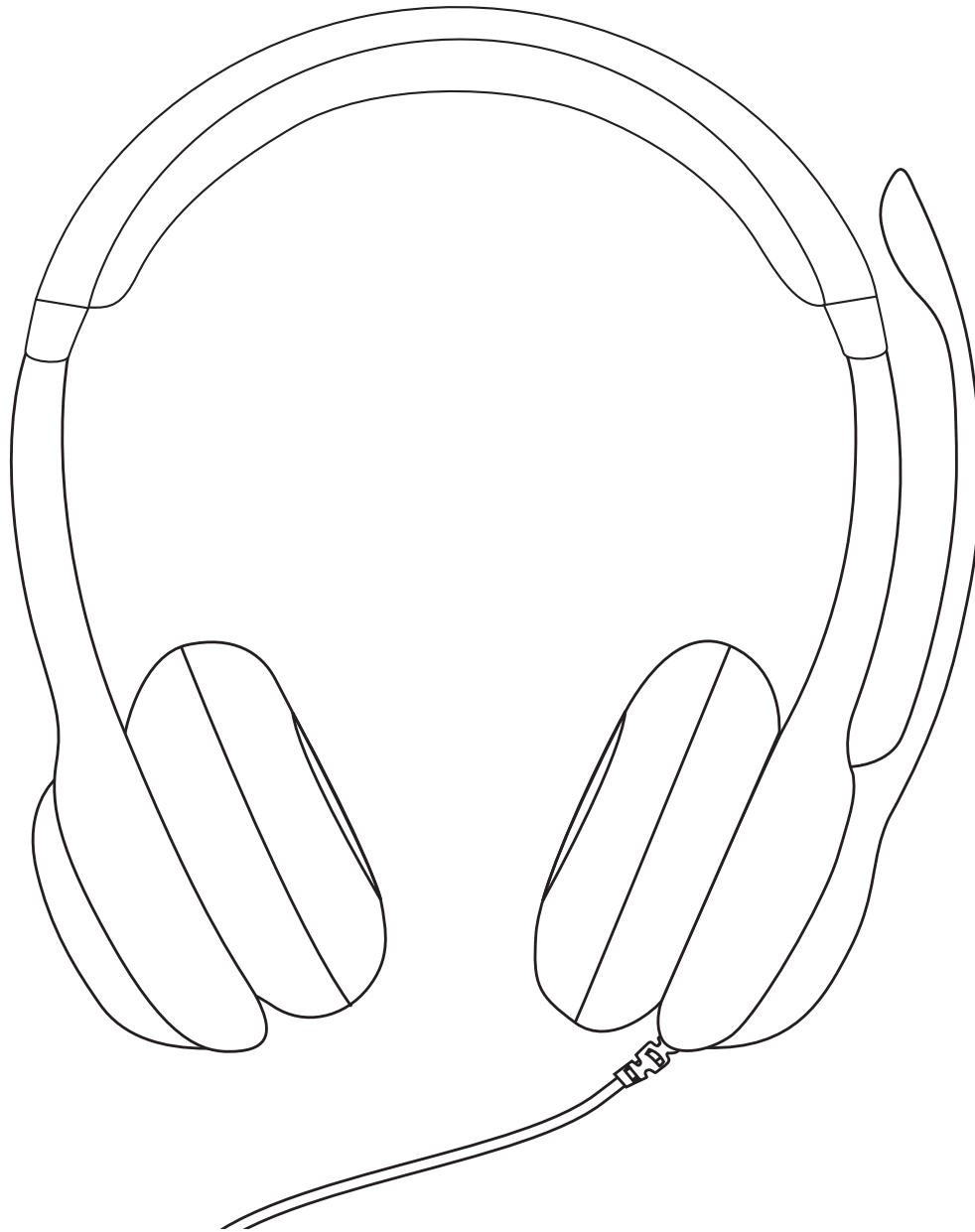

logitech®

## CONTENTS

English . . . . .3

Français . . . . .6

Español. . . . .9

Português . . . . . 12

**KNOW YOUR PRODUCT**

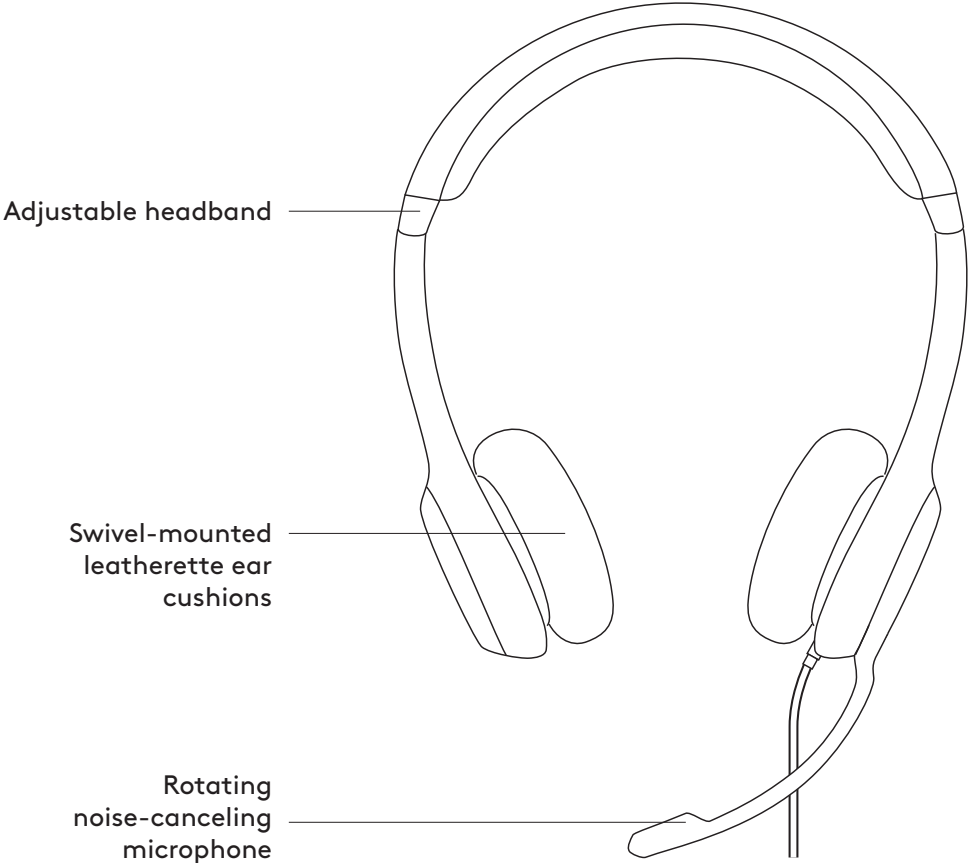

**IN-LINE CONTROLLER**

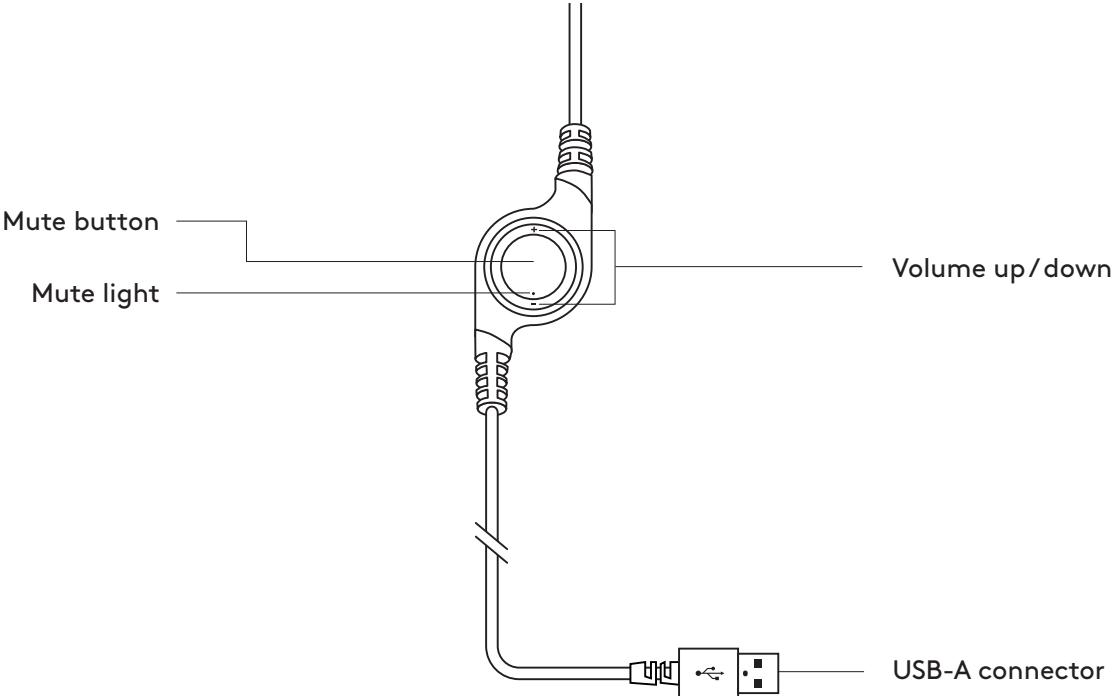

## CONNECTING THE HEADSET

Plug the USB-A connector into the computer USB port.

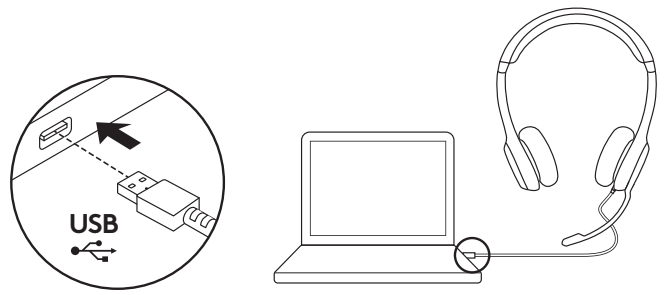

## HEADSET FIT

1. To adjust headset size, move the headband up and down until it fits comfortably.
2. Move the microphone boom up or down until it is level with your mouth for better voice capture.
3. Boom can be tucked out of the way when not being used.

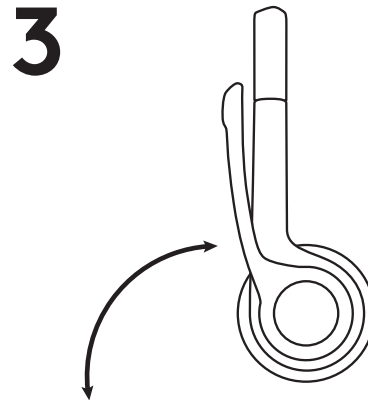
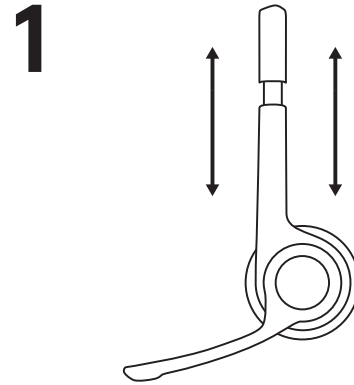

# CONTROLS

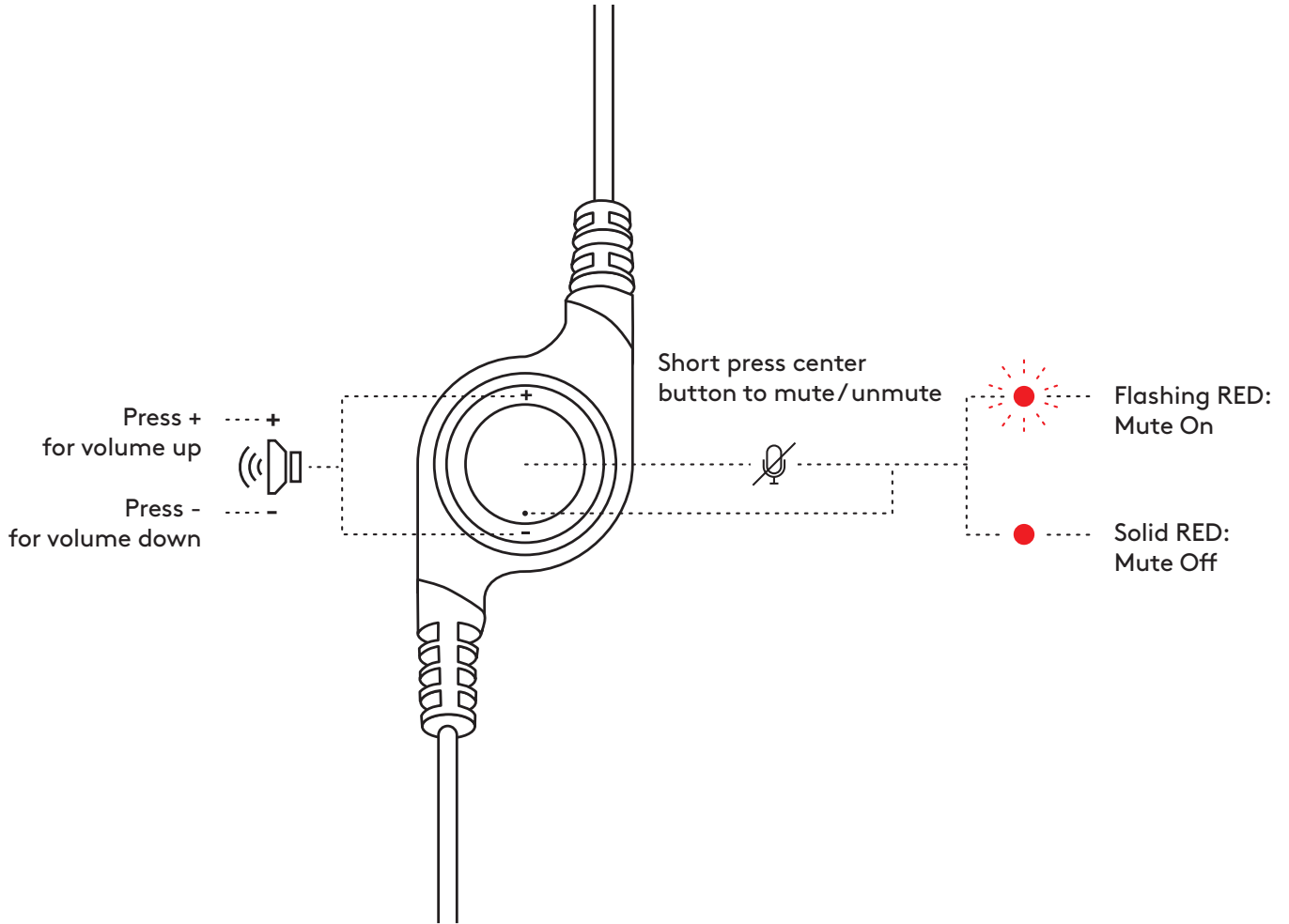

[www.logitech.com/support/H390](http://www.logitech.com/support/H390)

## PRÉSENTATION DU PRODUIT

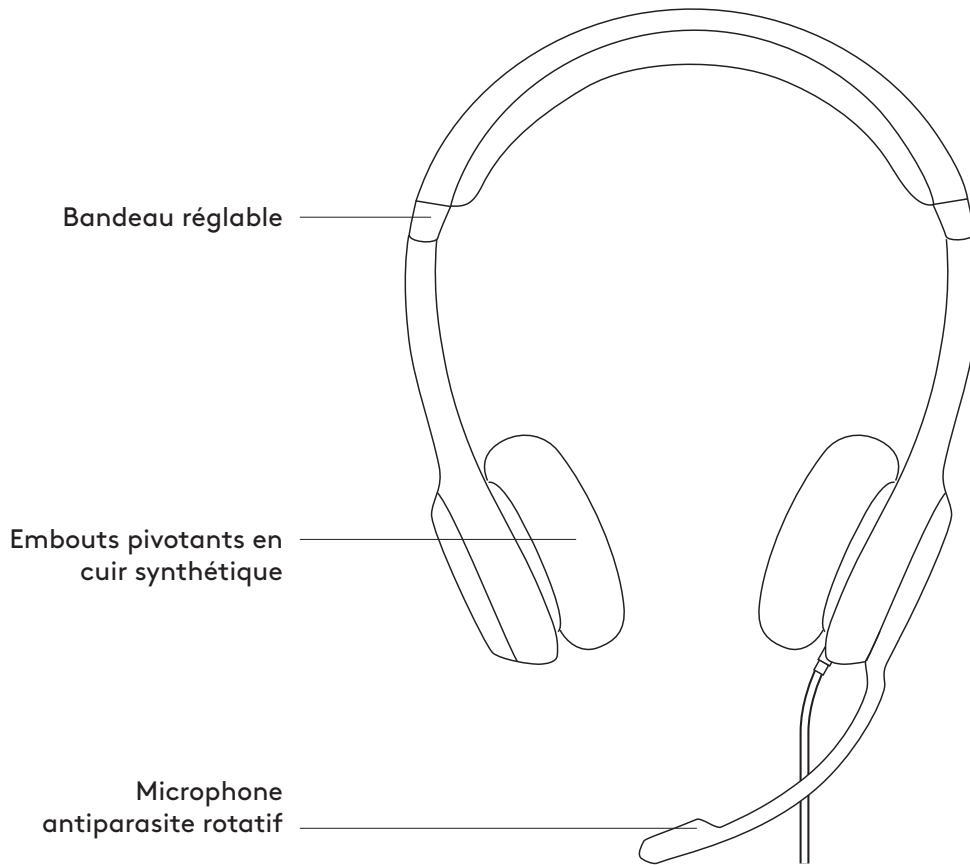

## CONTRÔLEUR INTÉGRÉ

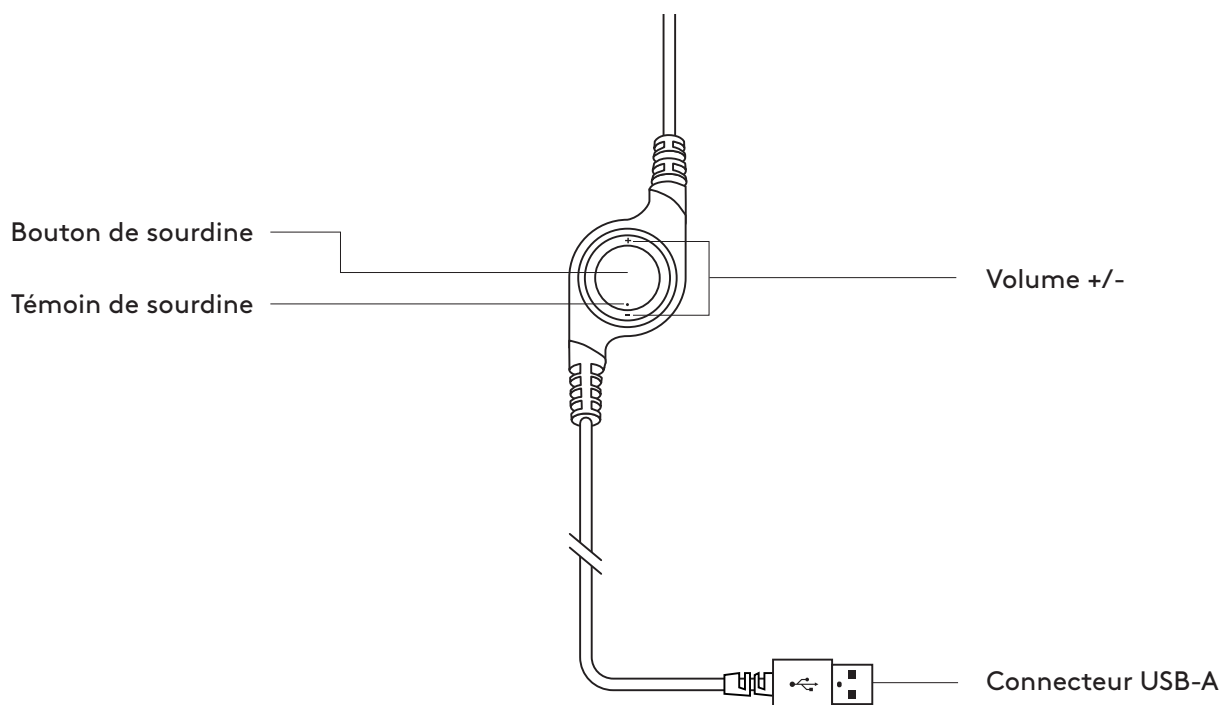

## BRANCHEMENT DU CASQUE

Branchez le connecteur USB-A sur un port USB de l'ordinateur.

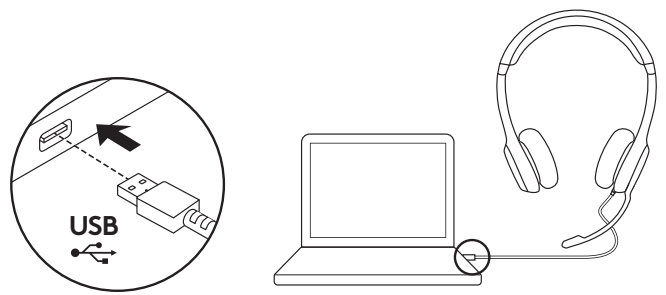

## AJUSTEMENT DU CASQUE

1. Pour ajuster la taille du casque, déplacez le bandeau de haut en bas jusqu'à ce qu'il soit confortable.
2. Déplacez la tige du microphone vers le haut ou vers le bas jusqu'à ce qu'elle soit au niveau de votre bouche pour une meilleure capture de la voix.
3. La tige peut être rabattue lorsque vous ne l'utilisez pas.

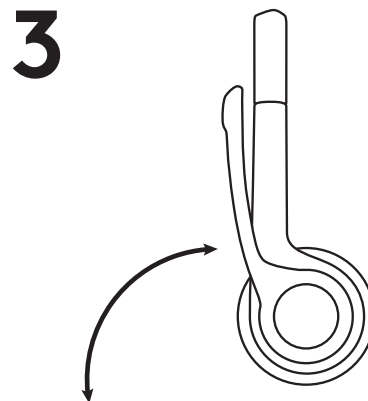
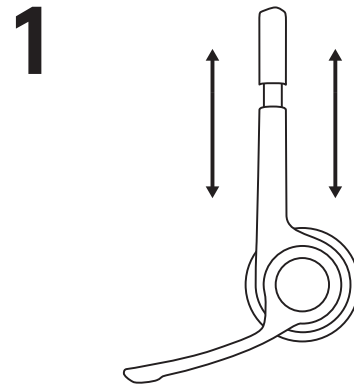

## COMMANDES

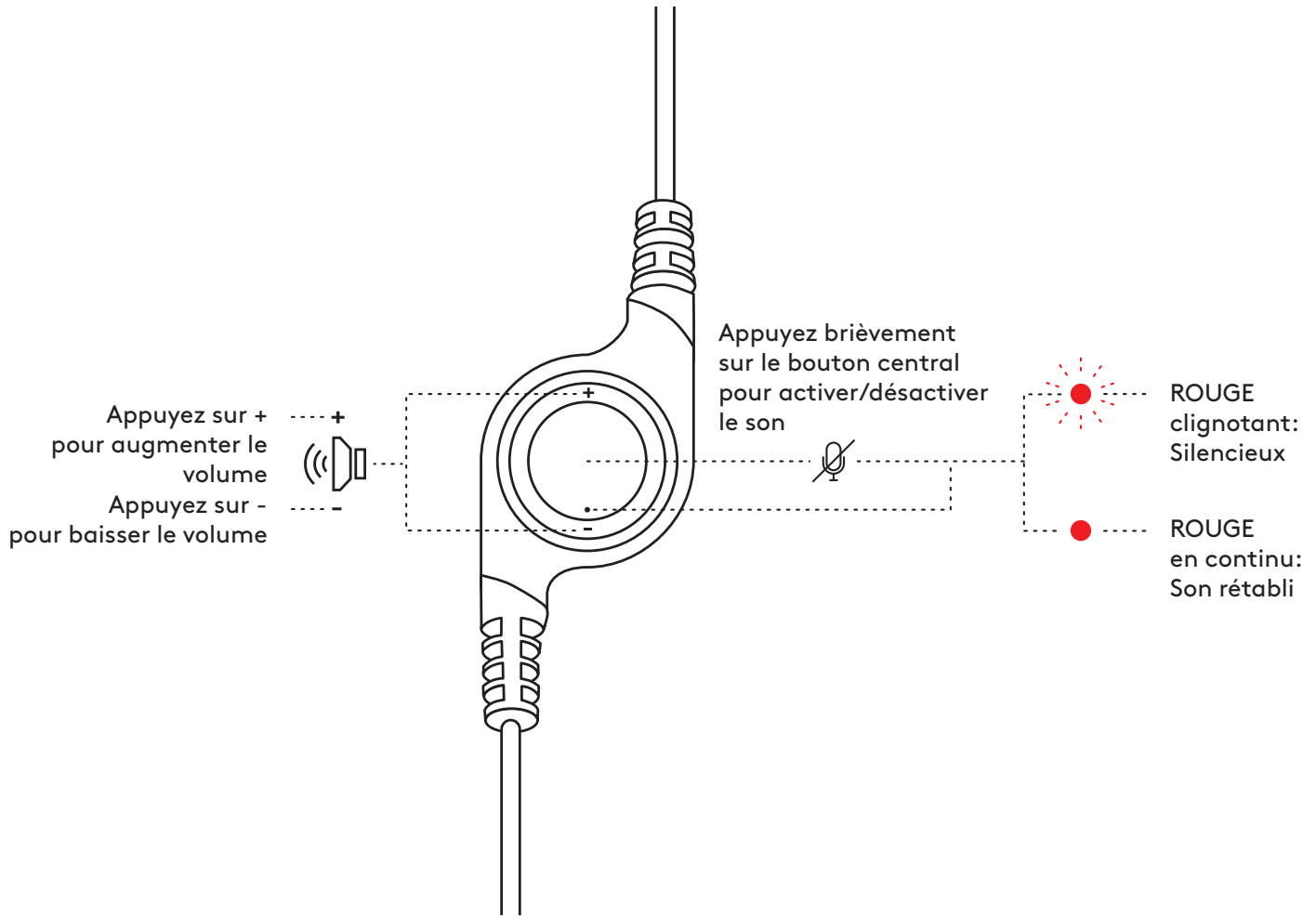

[www.logitech.com/support/H390](http://www.logitech.com/support/H390)



## COMPONENTES DEL PRODUCTO

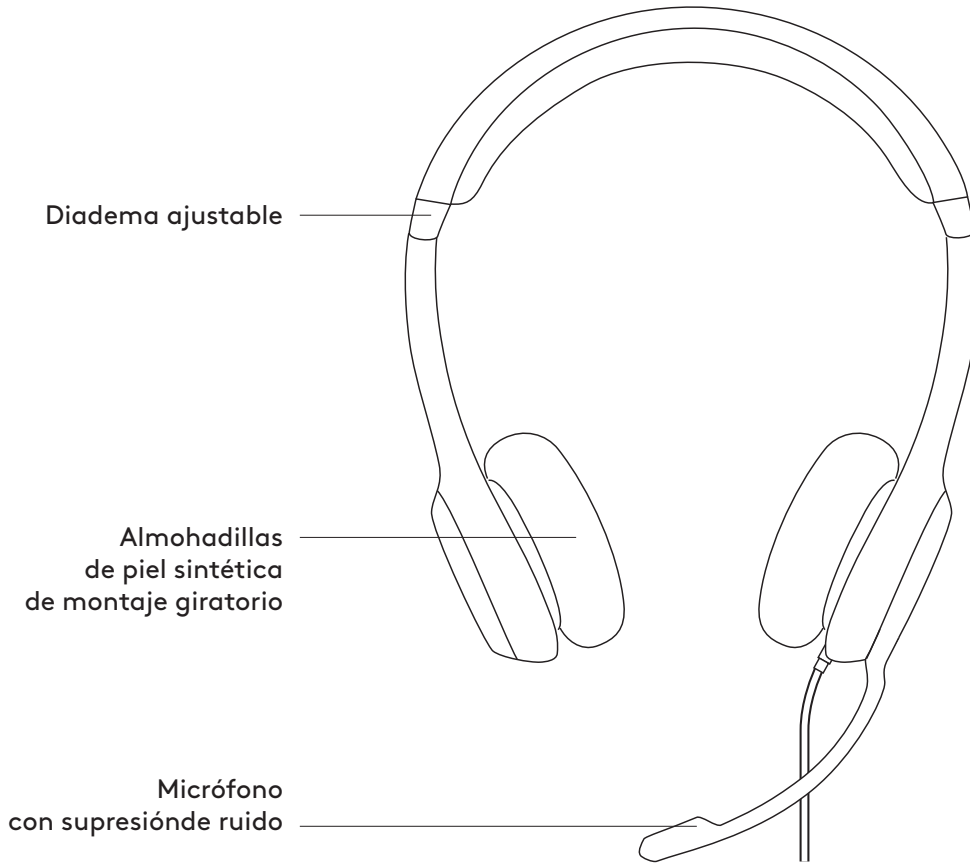

## CONTROLADOR INTEGRADO EN EL CABLE

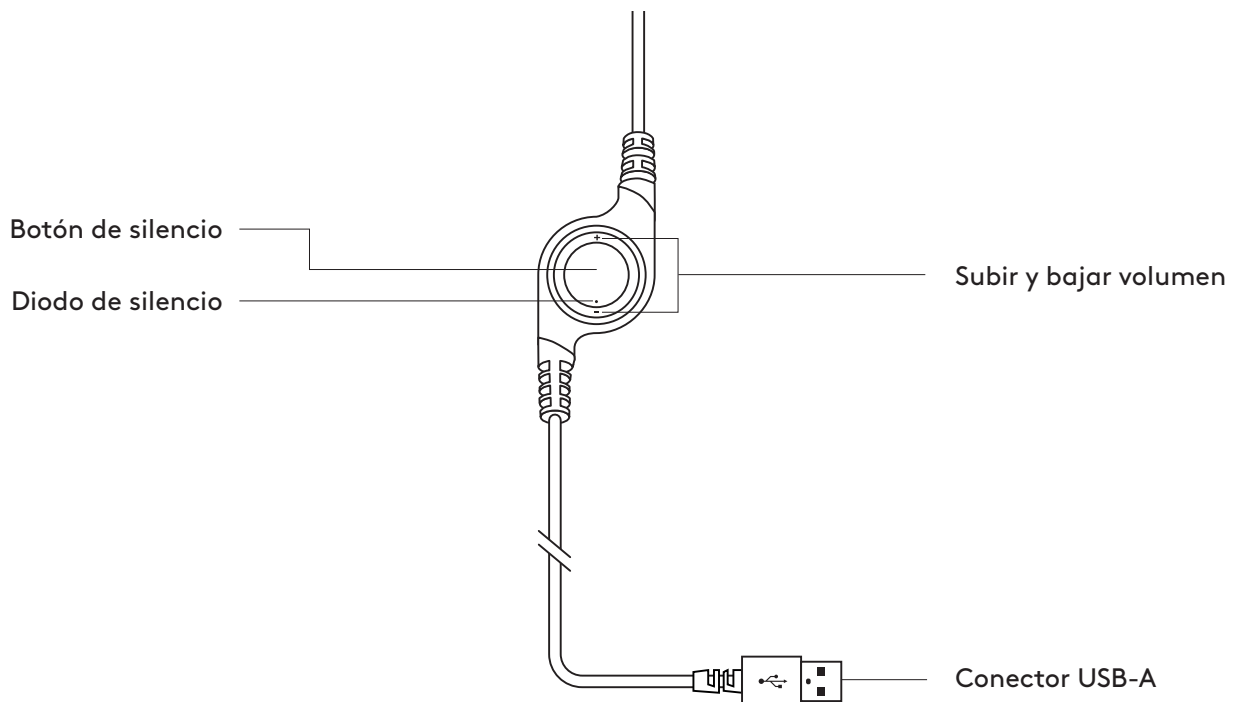

## CONEXIÓN DE LOS AUDÍFONOS

Conecta el conector USB-A al puerto USB de la computadora.

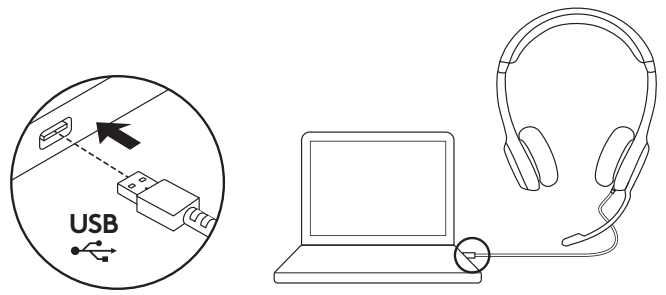

## AJUSTE DE LOS AUDÍFONOS

1. Para ajustar el tamaño de los audífonos, sube y baja la diadema hasta que te resulten confortables.
2. Mueve la varilla del micrófono hacia arriba o hacia abajo hasta que esté al nivel de la boca para una mejor captura de voz.
3. La varilla se puede guardar, para que no estorbe cuando no se use.

1

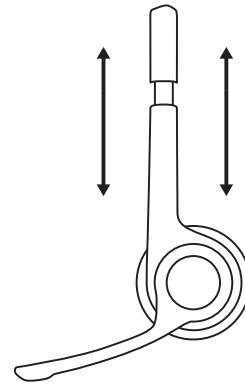

2

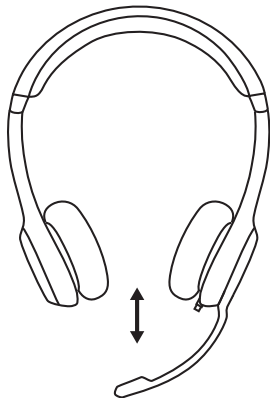

3

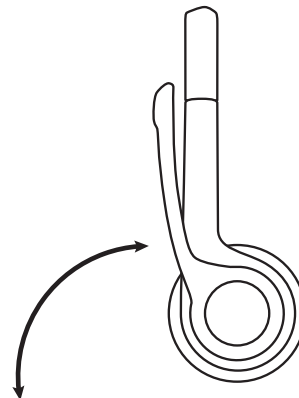

## CONTROLES

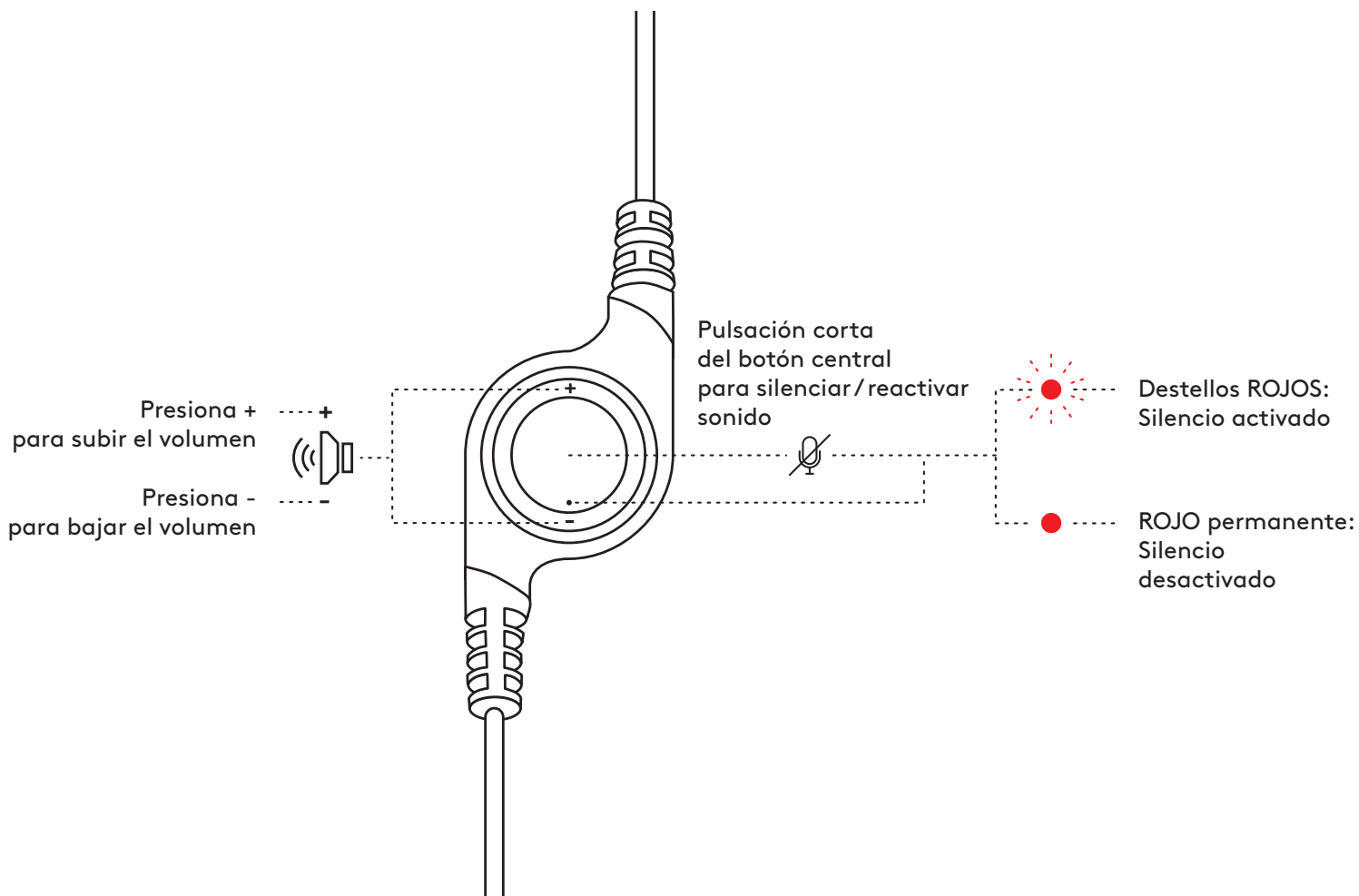

[www.logitech.com/support/H390](http://www.logitech.com/support/H390)

## CONHEÇA O SEU PRODUTO

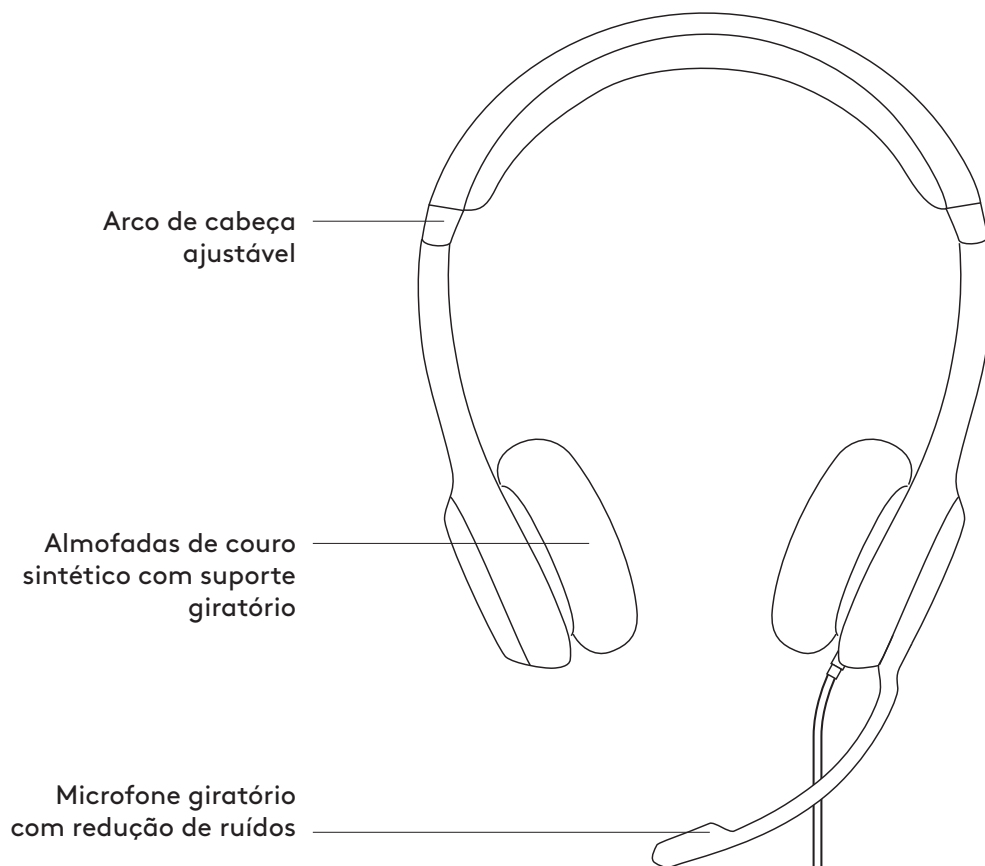

## CONTROLADOR INTEGRADO NO FIO

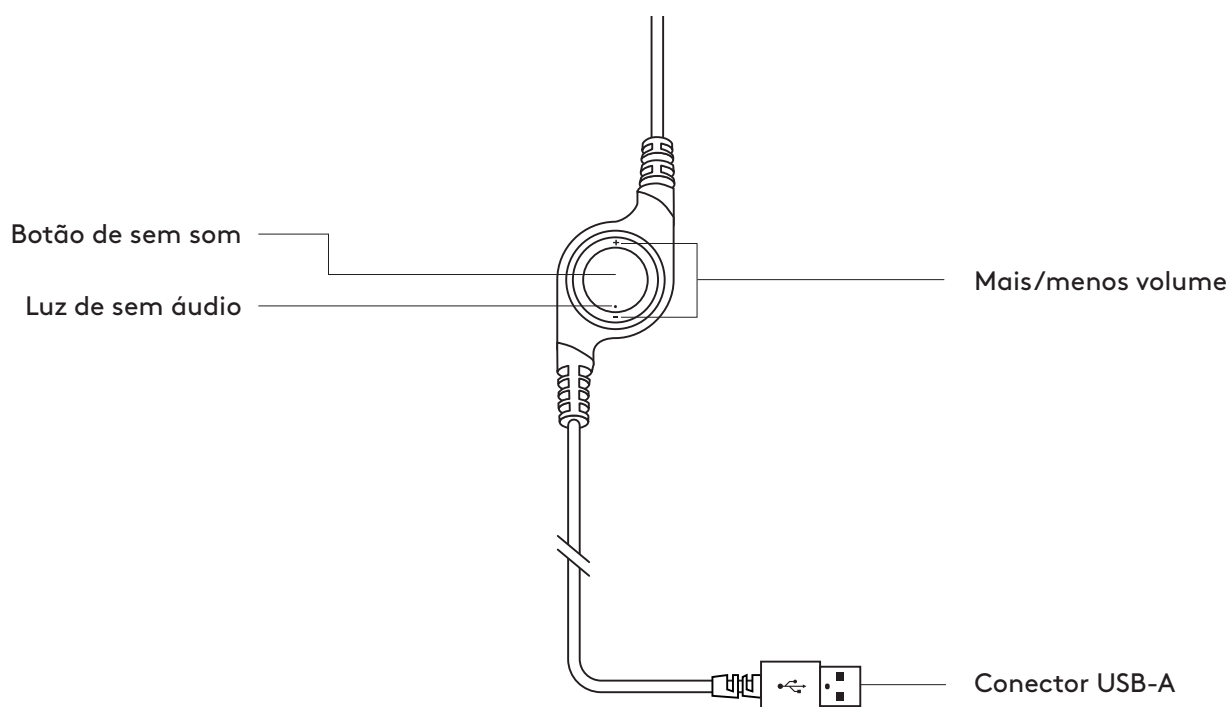

## CONECTANDO O HEADSET

Encaixe o conector USB-A na porta USB do computador.

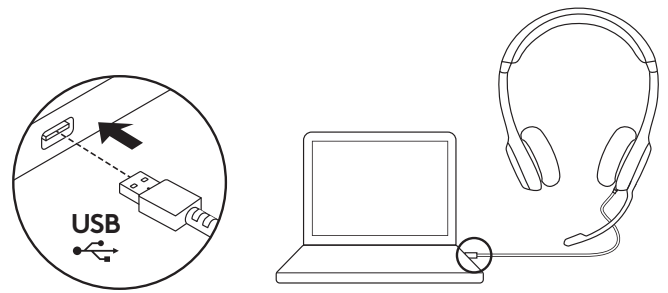

## AJUSTE DO HEADSET

1. Para ajustar o tamanho do headset movendo o arco de cabeça para cima e para baixo até que fique confortável.
2. Mova o microfone para cima ou para baixo até que esteja nivelado com sua boca para uma melhor captura de voz.
3. A haste do microfone pode ser levantada quando o microfone não estiver sendo utilizado.

1

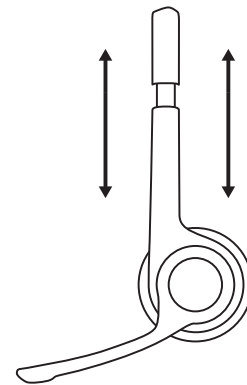

2

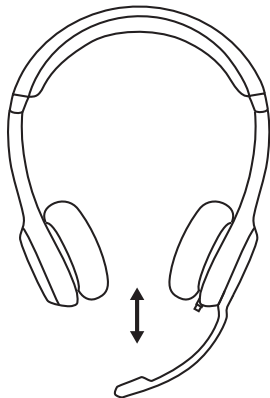

3

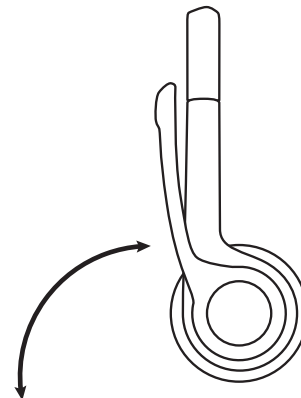

## CONTROLES

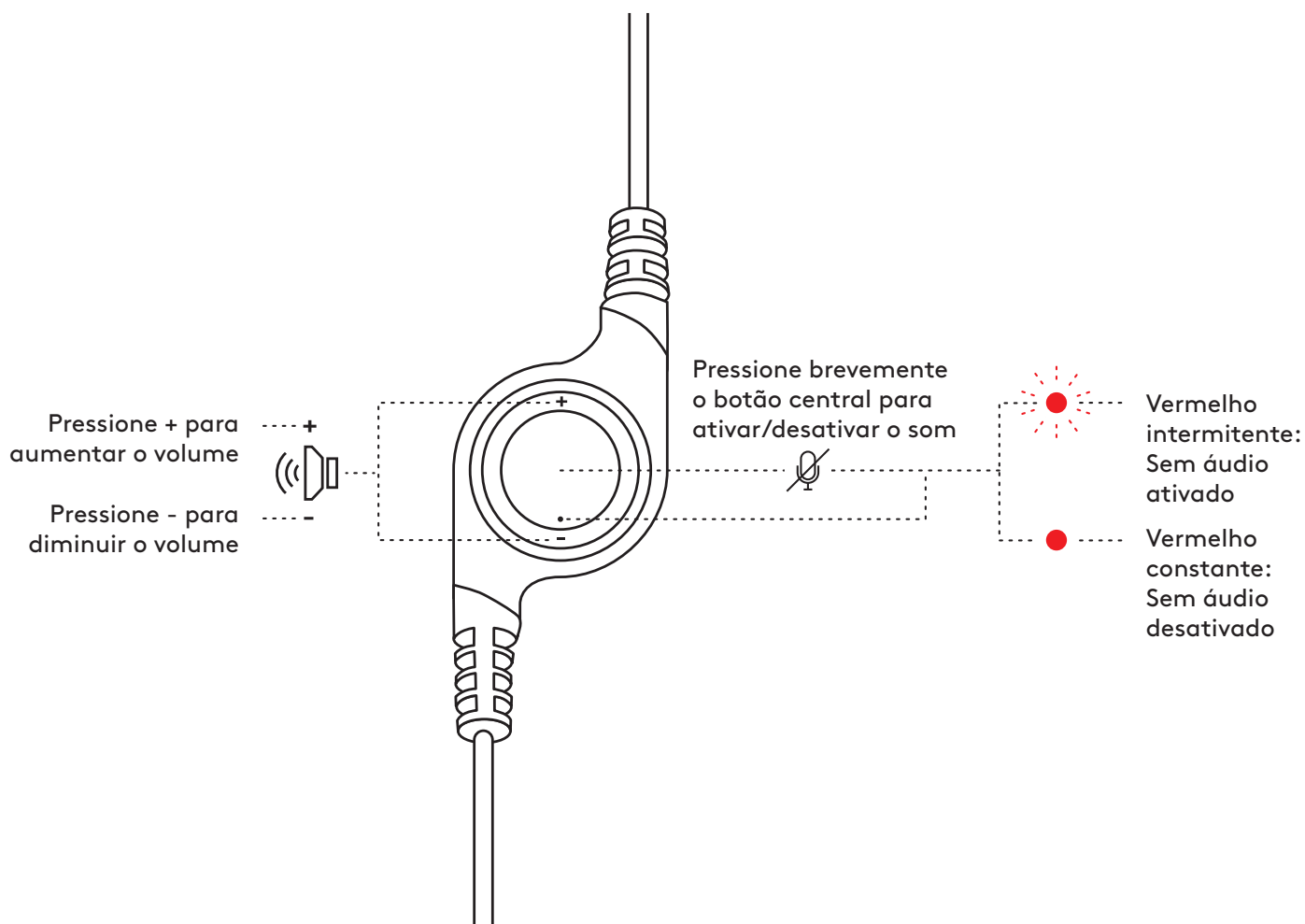

[www.logitech.com/support/H390](http://www.logitech.com/support/H390)